





VESTON

www.veston-electrics.ir



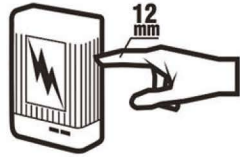
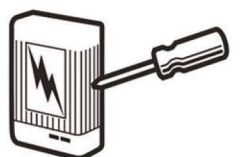







IP (Ingress Protection) Ratings Guide

SOLIDS

1		Protected against a solid object greater than 50 mm such as a hand.
2		Protected against a solid object greater than 12.5 mm such as a finger.
3		Protected against a solid object greater than 2.5 mm such as a screwdriver.
4		Protected against a solid object greater than 1 mm such as a wire.
5		Dust Protected. Limited ingress of dust permitted. Will not interfere with operation of the equipment. Two to eight hours.
6		Dust tight. No Ingress of dust. Two to eight hours.

WATER

1		Protected against vertically falling drops of water. Limited ingress permitted.
2		Protected against vertically falling drops of water with enclosure tilted up to 15 degrees from the vertical. Limited ingress permitted.
3		Protected against sprays of water up to 60 degrees from the vertical. Limited ingress permitted for three minutes.
4		Protected against water splashed from all directions. Limited ingress permitted.
5		Protected against jets of water. Limited ingress permitted.
6		Water from heavy seas or water projected in powerful jets shall not enter the enclosure in harmful quantities.
7		Protection against the effects of immersion in water between 15 cm and 1 m for 30 minutes.
8		Protection against the effects of immersion in water under pressure for long periods.

Rating Example:

IP65

INGRESS PROTECTION

Junction Boxes



ORDER-NO	Dimensions(mm)
VE-JBI 10060	100*100*60
VE-JBI 10070	100*100*70
VE-JBI 12585	125*125*85
VE-JBI 15575	155*155*75
VE-JBI 155100	155*155*100
VE-JBI 185095	185*185*95
VE-JBI 185135	185*185*135
VE-JBI 220120	220*220*120
VE-JBI 250160	250*250*160
VE-JBI 300140	300*200*140
VE-JBI 315190	315*315*190
VE-JBI 350160	350*300*160
VE-JBI 400170	400*350*170
VE-JBI 360200	360*360*200



Junction Box IP 67

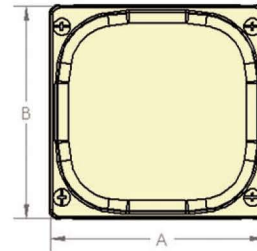
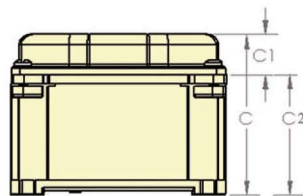

ORDER-NO	Dimensions(mm)			Cover height(mm) C1	Body height(mm) C2
	A	B	C		
VE-JBI 10060	100	100	60	10	50
VE-JBI 10070	100	100	70	20	50

Conformity to standards	IEC/EN60670-1
Material	Aluminium Alloy
Colour	Hot Polymerized non-toxic Epoxy
	Main Ral 7001
	By choice
Storage Temperature	-20C +90 C
Operating Temperature	-20C +90C

- 1-It is proper to be used for indoor,outdoor or coastal in harmful environment where expected to be contact with sea water.
2. It can be used in wide temperature range.
- 3.It has excellent resistance against chemicals.

Junction Box IP 67

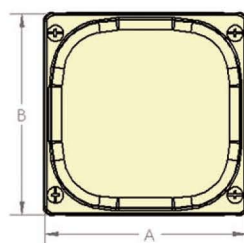
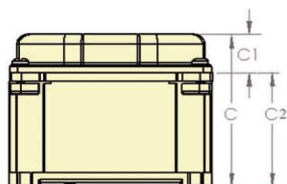

ORDER-NO	Dimensions(mm)			Cover height(mm) C1	Body height(mm) C2
	A	B	C		
VE-JBI 155075	155	155	75	10	65
VE-JBI 155100	155	155	100	35	65

Conformity to standards	IEC/EN60670-1
Material	Aluminium Alloy
Colour	Hot Polymerized non-toxic Epoxy
	Main Ral 7001
	By choice
Storage Temperature	-20C +90 C
Operating Temperature	-20C +90C

- 1-It is proper to be used for indoor,outdoor or coastal in harmful environment where expected to be contact with sea water.
2. It can be used in wide temperature range.
- 3.It has excellent resistance against chemicals.

Junction Box IP 67

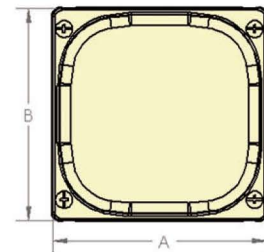
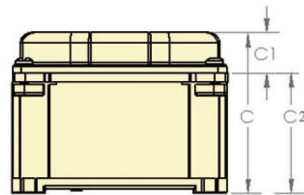

ORDER-NO	Dimensions(mm)			Cover height(mm) C1	Body height(mm) C2
	A	B	C		
VE-JBI 185095	185	185	95	10	85
VE-JBI 185135	185	185	135	50	85

Conformity to standards	IEC/EN60670-1
Material	Aluminium Alloy
Colour	Hot Polymerized non-toxic Epoxy
	Main Ral 7001
	By choice
Storage Temperature	-20C +90 C
Operating Temperature	-20C +90C

- 1-It is proper to be used for indoor,outdoor or coastal in harmful environment where expected to be contact with sea water.
2. It can be used in wide temperature range.
- 3.It has excellent resistance against chemicals.

Junction Box IP 67

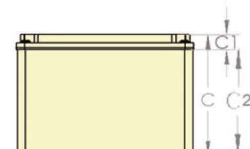
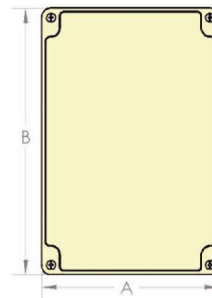
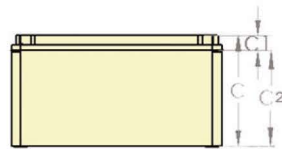
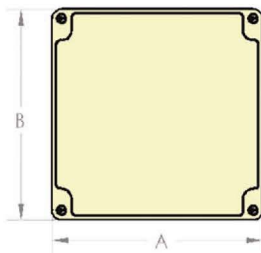

ORDER-NO	Dimensions(mm)			Cover	Body
	A	B	C	height(mm) C1	height(mm) C2
VE-JBI 220120	220	220	120	14	106
VE-JBI 250160	250	250	160	14	146
VE-JBI 300140	300	200	140	14	106

Conformity to standards	IEC/EN60670-1
Material	Aluminium Alloy
Colour	Hot Polymerized non-toxic Epoxy
	Main Ral 7001
	By choice
Storage Temperature	-20C +90 C
Operating Temperature	-20C +90C

- 1-It is proper to be used for indoor,outdoor or coastal in harmful environment where expected to be contact with sea water.
2. It can be used in wide temperature range.
- 3.It has excellent resistance against chemicals.

Junction Box IP 67

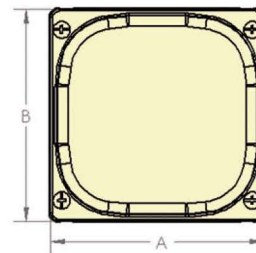
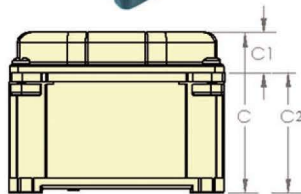

ORDER-NO	Dimensions(mm)			Cover height(mm) C1	Body height(mm) C2
	A	B	C		
VE-JBI 125085	125	125	85	20	65
VE-JBI 315190	315	315	190	50	140

Conformity to standards	IEC/EN60670-1
Material	Aluminium Alloy
Colour	Hot Polymerized non-toxic Epoxy
	Main Ral 7001
	By choice
Storage Temperature	-20C +90 C
Operating Temperature	-20C +90C

- 1-It is proper to be used for indoor,outdoor or coastal in harmful environment where expected to be contact with sea water.
2. It can be used in wide temperature range.
- 3.It has excellent resistance against chemicals.

Junction Box IP 67

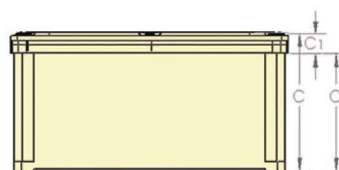
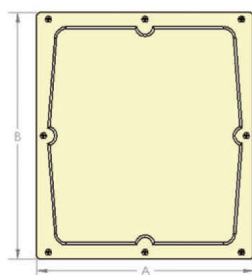
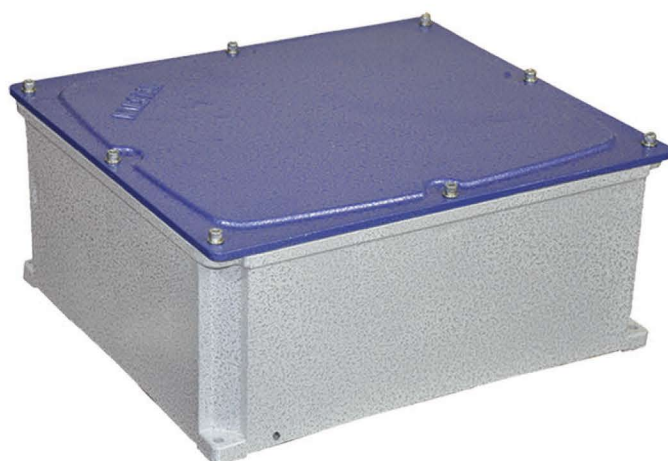

ORDER-NO	Dimensions(mm)			Cover height(mm) C1	Body height(mm) C2
	A	B	C		
VE-JBI 350160	350	300	160	10	150
VE-JBI 400170	400	350	170	10	160

Conformity to standards	IEC/EN60670-1
Material	Aluminium Alloy
Colour	Hot Polymerized non-toxic Epoxy
	Main Ral 7001
	By choice
Storage Temperature	-20C +90 C
Operating Temperature	-20C +90C

- 1-It is proper to be used for indoor,outdoor or coastal in harmful environment where expected to be contact with sea water.
2. It can be used in wide temperature range.
- 3.It has excellent resistance against chemicals.

Conduit Body(C)



ORDER-NO	INCH-Size
VE-CC012	1/2
VE-CC034	3/4
VE-CC001	1
VE-CC114	1 1/4
VE-CC112	1 1/2
VE-CC002	2
VE-CC212	2 1/2
VE-CC003	3
VE-CC004	4

ORDER-NO	Size-PG
VE-CP11	11
VE-CP13	13
VE-CP16	16
VE-CP21	21
VE-CP29	25
VE-CP36	36
VE-CP42	42
VE-CP48	48

Description:

to provide access to conductors for pulling splicing and maintenance

Material: Alloy Aluminium

Conduit Body(LL)



ORDER-NO	INCH-Size	ORDER-NO	Size-PG
VE-CC012	1/2	VE-CP11	11
VE-CC034	3/4	VE-CP13	13
VE-CC001	1	VE-CP16	16
VE-CC114	1 1/4	VE-CP21	21
VE-CC112	1 1/2	VE-CP29	25
VE-CC002	2	VE-CP36	36
VE-CC212	2 1/2	VE-CP42	42
VE-CC003	3	VE-CP48	48
VE-CC004	4		

Description:

to provide access to conductors for pulling splicing and maintenance

Material: Alloy Aluminium

Conduit Body(LR)

ORDER-NO	INCH-Size
VE-CC012	1/2
VE-CC034	3/4
VE-CC001	1
VE-CC114	1 1/4
VE-CC112	1 1/2
VE-CC002	2
VE-CC212	2 1/2
VE-CC003	3
VE-CC004	4

ORDER-NO	Size-PG
VE-CP11	11
VE-CP13	13
VE-CP16	16
VE-CP21	21
VE-CP29	25
VE-CP36	36
VE-CP42	42
VE-CP48	48

Description:

to provide access to conductors for pulling splicing and maintenance

Material: Alloy Aluminium

Conduit Body(LB)



ORDER-NO	INCH-Size
VE-CC012	1/2
VE-CC034	3/4
VE-CC001	1
VE-CC114	1 1/4
VE-CC112	1 1/2
VE-CC002	2
VE-CC212	2 1/2
VE-CC003	3
VE-CC004	4

ORDER-NO	Size-PG
VE-CP11	11
VE-CP13	13
VE-CP16	16
VE-CP21	21
VE-CP29	25
VE-CP36	36
VE-CP42	42
VE-CP48	48

Description:

to provide access to conductors for pulling splicing and maintenance

Material: Alloy Aluminium

Conduit Body(T)

ORDER-NO	INCH-Size
VE-CC012	1/2
VE-CC034	3/4
VE-CC001	1
VE-CC114	1 1/4
VE-CC112	1 1/2
VE-CC002	2
VE-CC212	2 1/2
VE-CC003	3
VE-CC004	4

ORDER-NO	Size-PG
VE-CP11	11
VE-CP13	13
VE-CP16	16
VE-CP21	21
VE-CP29	25
VE-CP36	36
VE-CP42	42
VE-CP48	48

Description:

to provide access to conductors for pulling splicing and maintenance

Material: Alloy Aluminium

Conduit Body Universal

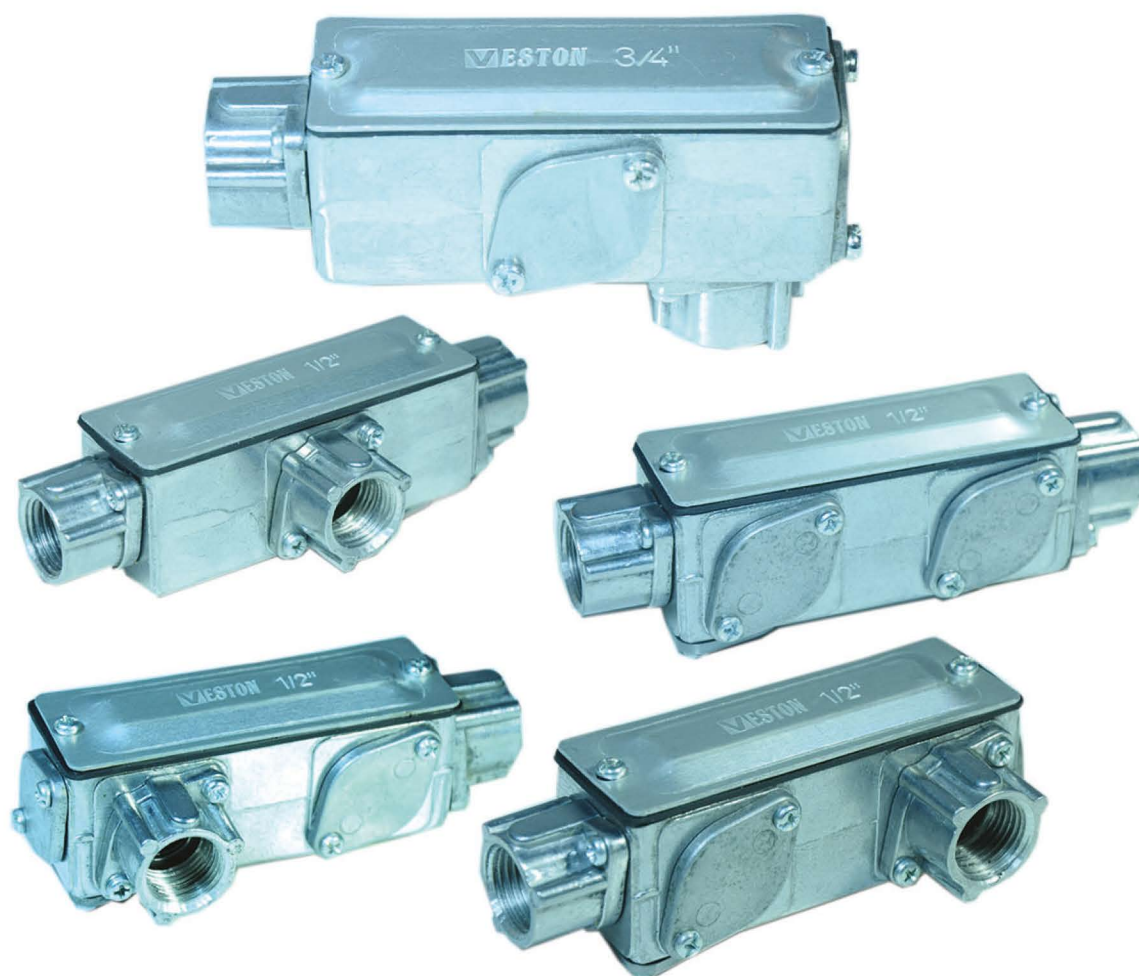

ORDER-NO	INCH-Size
VE-CC012	1/2
VE-CC034	3/4
VE-CC001	1
VE-CC114	1 1/4
VE-CC112	1 1/2
VE-CC002	2
VE-CC212	2 1/2
VE-CC003	3

ORDER-NO	Size-PG
VE-CP16	16
VE-CP21	21
VE-CP29	25
VE-CP36	36
VE-CP42	42
VE-CP48	48

Flexible Conduit Connector(Female)

ORDER-NO	Size-INCH
VE-C40038	3/8
VE-C40012	1/2
VE-C40034	3/4
VE-C40001	1
VE-C40114	1 1/4
VE-C40112	1 1/2
VE-C40002	2
VE-C40212	2 1/2
VE-C40003	3
VE-C40004	4
VE-C40005	5

ORDER-NO	Size-PG
VE-CP4011	11
VE-CP4013	13/5
VE-CP4016	16
VE-CP4021	21
VE-CP4029	29
VE-CP4036	36
VE-CP4042	42
VE-CP4048	48

ORDER-NO	Size-MM
VE-CM4020	20
VE-CM4025	25
VE-CM4032	32
VE-CM4040	40
VE-CM4050	50
VE-CM4063	63

Used liquid-tight and dust proof fitting for safety connection of liquid-tight flexible metal conduits installation plants.

Material: Body zinc

Gasket:soft PVC

protection rating IP65

Flexible Conduit Connector(Male)



ORDER-NO	Size-INCH
VE-C40038	3/8
VE-C40012	1/2
VE-C40034	3/4
VE-C40001	1
VE-C40114	1 1/4
VE-C40112	1 1/2
VE-C40002	2
VE-C40212	2 1/2
VE-C40003	3
VE-C40004	4
VE-C40005	5

ORDER-NO	Size-PG
VE-CP4011	11
VE-CP4013	13/5
VE-CP4016	16
VE-CP4021	21
VE-CP4029	29
VE-CP4036	36
VE-CP4042	42
VE-CP4048	48

ORDER-NO	Size-MM
VE-CM4020	20
VE-CM4025	25
VE-CM4032	32
VE-CM4040	40
VE-CM4050	50
VE-CM4063	63

Used liquid-tight and dust proof fitting for safety connection of liquid-tight flexible metal conduits installation plants.

Material: Body zinc

Gasket: soft PVC

protection rating IP65

90 Degree Flexible Conduit Connector

ORDER-NO	Size-INCH
VE-C40038	3/8
VE-C40012	1/2
VE-C40034	3/4
VE-C40001	1
VE-C40114	1 1/4
VE-C40112	1 1/2
VE-C40002	2
VE-C40212	2 1/2
VE-C40003	3
VE-C40004	4
VE-C40005	5

Used liquid-tight and dust proof fitting for safety connection of liquid-tight flexible metal conduits installation plants.

Material: Body zinc

Gasket: soft PVC

protection rating IP65

Union Connector



ORDER-NO	Size-INCH
VE-C40038	3/8
VE-C40012	1/2
VE-C40034	3/4
VE-C40001	1
VE-C40114	1 1/4
VE-C40112	1 1/2
VE-C40002	2
VE-C40212	2 1/2
VE-C40003	3
VE-C40004	4
VE-C40005	5

ORDER-NO	Size-PG
VE-CP4011	11
VE-CP4013	13/5
VE-CP4016	16
VE-CP4021	21
VE-CP4029	29
VE-CP4036	36
VE-CP4042	42
VE-CP4048	48

ORDER-NO	Size-MM
VE-CM4020	20
VE-CM4025	25
VE-CM4032	32
VE-CM4040	40
VE-CM4050	50
VE-CM4063	63

Material : Body zinc

Conduit Bushing



ORDER-NO	Size-INCH
VE-C40038	3/8
VE-C40012	1/2
VE-C40034	3/4
VE-C40001	1
VE-C40114	1 1/4
VE-C40112	1 1/2
VE-C40002	2
VE-C40212	2 1/2
VE-C40003	3
VE-C40004	4
VE-C40005	5

ORDER-NO	Size-PG
VE-CP4011	11
VE-CP4013	13/5
VE-CP4016	16
VE-CP4021	21
VE-CP4029	29
VE-CP4036	36
VE-CP4042	42
VE-CP4048	48

ORDER-NO	Size-MM
VE-CM4020	20
VE-CM4025	25
VE-CM4032	32
VE-CM4040	40
VE-CM4050	50
VE-CM4063	63

Material :

**Body zinc & Aluminium
galvanized**

Conduit Bushing



ORDER-NO	Size-INCH
VE-LN2012	1/2
VE-LN2234	3/4
VE-LN2201	1
VE-LN2214	1 1/4
VE-LN2212	1 1/2
VE-LN2202	2
VE-LN2212	2 1/2
VE-LN2203	3
VE-LN2204	4
VE-LN2205	5
VE-LN2206	6

ORDER-NO	Size-pG
VE-LNP11	11
VE-LNP13	13/5
VE-LNP16	16
VE-LNP21	21
VE-LNP29	29
VE-LNP36	36
VE-LNP42	42
VE-LNP48	48

ORDER-NO	Size-mm
VE-LNM20	20
VE-LNM32	32
VE-LNM40	40
VE-LNM50	50
VE-LNM63	63
VE-LNM75	75
VE-LNM100	100

- Material : Aluminum
- For rigid conduits

LockNut



ORDER-NO	Size-INCH
VE-LN2012	1/2
VE-LN2234	3/4
VE-LN2201	1
VE-LN2214	1 1/4
VE-LN2212	1 1/2
VE-LN2202	2
VE-LN2212	2 1/2
VE-LN2203	3
VE-LN2204	4
VE-LN2205	5
VE-LN2206	6

ORDER-NO	Size-pG
VE-LNP11	11
VE-LNP13	13/5
VE-LNP16	16
VE-LNP21	21
VE-LNP29	29
VE-LNP36	36
VE-LNP42	42
VE-LNP48	48

ORDER-NO	Size-mm
VE-LNM20	20
VE-LNM32	32
VE-LNM40	40
VE-LNM50	50
VE-LNM63	63
VE-LNM75	75
VE-LNM100	100

- Material : Body steel
- Used to secure an ordinary nut from working loose
by locking itself when screwed down tight
- For rigid conduits

Reducer



ORDER-NO	MALE	FEMALE
VE-R60001	1/4	3/8
VE-R60002	3/8	1/4
VE-R60003	1/4	1/2
VE-R60004	3/8	1/2
VE-R60005	1/2	1/4
VE-R60006	1/2	3/8
VE-R60007	1/2	3/4
VE-R60008	3/4	3/8
VE-R60009	3/4	1/2
VE-R60010	3/4	1
VE-R60011	1	1/2
VE-R60012	1	3/4
VE-R60013	1	1 1/4
VE-R60014	1	1 1/2
VE-R60015	1	2
VE-R60016	1 1/4	1/2
VE-R60017	1 1/4	3/4
VE-R60018	1 1/4	1
VE-R60019	1 1/4	1 1/2
VE-R60020	1 1/4	2
VE-R60021	1 1/2	3/4
VE-R60022	1 1/2	1
VE-R60023	1 1/2	1 1/4
VE-R60024	1 1/2	2
VE-R60025	2	3/4
VE-R60026	2	1
VE-R60027	2	1 1/4
VE-R60028	2	1 1/2
VE-R60029	2	2 1/2

ORDER-NO	MALE	FEMALE
VE-R60030	2	3
VE-R60031	2 1/2	1 1/2
VE-R60032	2 1/2	2
VE-R60034	2 1/2	3
VE-R60035	3	2
VE-R60036	3	2 1/2
VE-R60037	3	4

Can be ordered fore production :

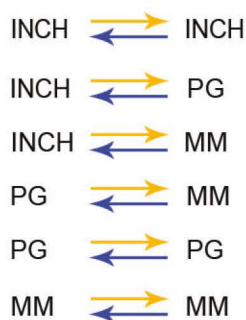

Reducer INCH*PG



ORDER-NO	MALE	FEMALE
VE-60050	1/4	7
VE-60051	1/4	9
VE-60052	3/8	9
VE-60053	3/8	11
VE-60054	1/2	9
VE-60055	1/2	11
VE-60056	1/2	13/5
VE-60057	1/2	16
VE-60058	3/4	11
VE-60059	3/4	13/5
VE-60060	3/4	16
VE-60061	3/4	21
VE-60062	1	16
VE-60063	1	21
VE-60064	1	29
VE-60065	1 1/4	29
VE-60066	1 1/4	36
VE-60067	1 1/2	29
VE-60068	1 1/2	36
VE-60069	1 1/2	42
VE-60070	2	29
VE-60071	2	36
VE-60072	2	42
VE-60073	2	48
VE-60074	2 1/2	48

Cable Glands IP68



Material: Nickel plated brass

ORDER-NO	Size-INCH	Cable-Diameter
VE-G14	1/4	3-7
VE-G38	3/8	4-8
VE-G12	1/2	8-12
VE-G34	3/4	13-18
VE-G 1	1	15-22
VE-G114	1 1/4	22-28
VE-G112	1 1/2	25-32
VE-G 2	2	37-44
VE-G212	2 1/2	42-52
VE-G3	3	65-70

ORDER-NO	Size-MM	Cable-Diameter
VE-M12	12*1.5	3-6.5
VE-M16	16*1.5	4-10
VE-M20	20*1.5	6-11
VE-M25	25*1.5	13-18
VE-M32	32*1.5	16-21
VE-M40	40*1.5	22-32
VE-M50	50*1.5	32-38
VE-M63	63*1.5	37-44
VE-M75	75*1.5	42-52
VE-M80	80*1.5	55-60
VE-M100	100*1.5	75-84

ORDER-NO	Size-PG	Cable-Diameter
VE-PG7	7	6
VE-PG9	9	7
VE-PG11	11	8
VE-PG13	13	8
VE-PG21	21	9
VE-PG29	29	10
VE-PG36	36	10
VE-PG42	42	12
VE-PG48	48	12
VE-PG63	63	15

Pipe Flexible



ORDER-NO	Size-INCH
VE- FC2012	1/2
VE- FC 2234	3/4
VE- FC 2201	1
VE- FC 2214	1 1/4
VE- FC 2212	1 1/2
VE- FC 2202	2
VE- FC 2212	2 1/2
VE- FC 2203	3
VE- FC 2204	4
VE- FC 2205	5
VE- FC 2206	6

ORDER-NO	Size-pG
VE- FC P11	11
VE- FC P13	13/5
VE- FC P16	16
VE- FC P21	21
VE- FC P29	29
VE- FC P36	36
VE- FC P42	42
VE- FC P48	48
VE- FC P52	52
VE- FC P63	63
VE- FC P75	75
VE- FC P80	80
VE-FC P100	100

Specifications :

Flexible wicker, PVC coated

Pipe Conduit & Accessories



ORDER-NO	Size-INCH	ORDER-NO	Size-pG	ORDER-NO	Size-mm
VE-EC2012	1/2	VE- EC P11	11	VE- EC M20	20
VE- EC 2234	3/4	VE- EC P13	13/5	VE- EC M32	32
VE- EC 2201	1	VE- EC P16	16	VE- EC M40	40
VE- EC 2214	1 1/4	VE- EC P21	21	VE- EC M50	50
VE- EC 2212	1 1/2	VE- EC P29	29	VE- EC M63	63
VE- EC 2202	2	VE- EC P36	36	VE- EC M75	75
VE- EC 2212	2 1/2	VE- EC P42	42	VE- EC M100	100
VE- EC 2203	3	VE- EC P48	48		
VE- EC 2204	4				
VE- EC 2205	5				
VE- EC 2206	6				

Specifications

ST37 Sheet - Hot, Cold Galvanized Plating

C-Channel

G 41 x 21 x 2 - 2,5 mm

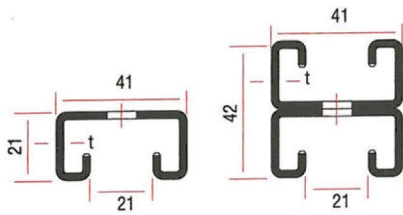

Code	t mm	a x b mm	c mm	Unit weight Kg/m
PLGD4121	2,5	-	-	1,89
PLGD4121.01	2,0	-	-	1,52
PLGSD4121	2,5	12,5 x 25	34,5	1,80
PLGSD4121.01	2,0	12,5 x 25	34,5	1,44
PLGDD4121	2,5	12,5 x 25	34,5	3,60
PLGDD4121.01	2,0	12,5 x 25	34,5	2,88

Standard Length : 4.000, 6.000 mm

PLGD 4121

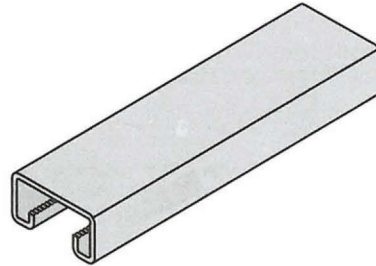

PLGSD 4121

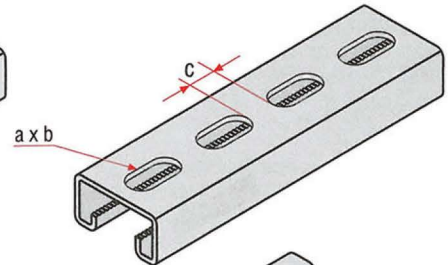

PLGDD 4142

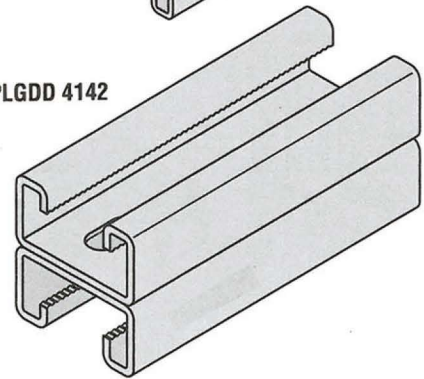

G 41 x 41 x 2 - 2,5 mm

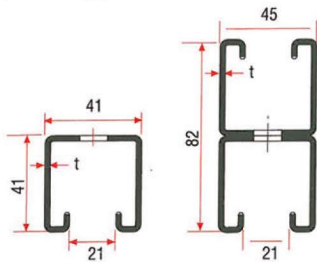

Code	t mm	a x b mm	c mm	Unit weight Kg/m
PLGD4141	2,5	-	-	2,68
PLGD4141.01	2,0	-	-	2,14
PLGSD4141	2,5	12,5 x 25	34,5	2,59
PLGSD4141.01	2,0	12,5 x 25	34,5	2,07
PLGDD4182	2,5	12,5 x 25	34,5	5,18
PLGDD4182.01	2,0	12,5 x 25	34,5	4,14

Standard Length : 4.000, 6.000 mm

PLGD 4141

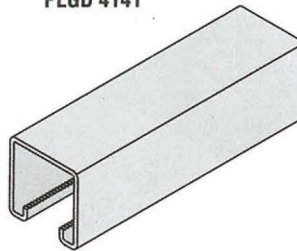

PLGSD 4141

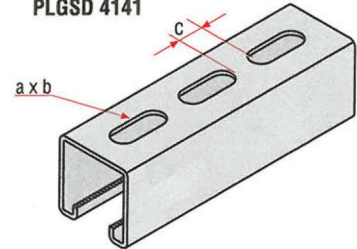

PLGDD 4182

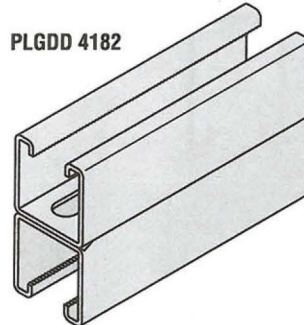

G Strut Pipe Clamps

Material :
Steel

Standard Finish :
Electro Plated Zinc or Hot-Dip Galvanized or Cooper Plated.

Service :
Designed for hanger and support of uninsulated pipes and cable trays with PROLINK G framing channels.

PLGK Dimensions

Code	mm	Unit Weight kg	Design Load 1 kN	Design Load 2 kN	Design Load 3 kN
PLGK.2006	6-8	0,05	1,78	0,22	0,22
PLGK.2008	8-11	0,05	1,78	0,22	0,22
PLGK.2011	11-12	0,05	1,78	0,22	0,22
PLGK.2015	15-17	0,06	1,78	0,22	0,22
PLGK.2018	18-20	0,06	1,78	0,22	0,22
PLGK.2020	20-24	0,06	1,78	0,22	0,22
PLGK.2021	21-23	0,06	2,67	0,33	0,33
PLGK.2023	23-26	0,06	2,67	0,33	0,33
PLGK.2026	26-29	0,06	2,67	0,33	0,33
PLGK.2029	29-32	0,06	2,67	0,33	0,33
PLGK.2032	32-36	0,07	3,56	0,56	0,56
PLGK.2036	36-39	0,07	3,56	0,56	0,56
PLGK.2039	39-42	0,07	3,56	0,56	0,56
PLGK.2042	42-45	0,07	3,56	0,56	0,56
PLGK.2046	46-50	0,08	3,56	0,56	0,56
PLGK.2048	48-54	0,08	3,56	0,56	0,56
PLGK.2050	50-54	0,08	3,56	0,56	0,56
PLGK.2052	52-56	0,11	3,56	0,56	0,56
PLGK.2056	56-60	0,12	3,56	0,56	0,56
PLGK.2060	60-63	0,13	3,56	0,56	0,56
PLGK.2062	62-64	0,13	3,56	0,56	0,56
PLGK.2064	64-67	0,13	3,56	0,56	0,56
PLGK.2067	67-71	0,14	3,56	0,56	0,56
PLGK.2070	71-74	0,16	3,56	0,56	0,56
PLGK.2074	74-77	0,17	3,56	0,56	0,56
PLGK.2077	77-80	0,20	3,56	0,56	0,56
PLGK.2083	83-86	0,21	3,56	0,56	0,56
PLGK.2086	86-90	0,23	4,45	0,89	0,67
PLGK.2096	96-100	0,24	4,45	0,89	0,67
PLGK.2100	100-103	0,24	4,45	0,89	0,67
PLGK.2109	109-112	0,26	4,45	0,89	0,67
PLGK.2112	112-115	0,28	4,45	0,89	0,67
PLGK.2115	115-118	0,32	4,45	0,89	0,67
PLGK.2125	125-128	0,38	4,45	0,89	0,67
PLGK.2132	132-135	0,40	4,45	0,89	0,67
PLGK.2135	135-138	0,42	4,45	0,89	0,67
PLGK.2138	138-141	0,45	4,45	0,89	0,67
PLGK.2148	148-151	0,45	4,45	0,89	0,67
PLGK.2157	157-160	0,46	4,45	0,89	0,67
PLGK.2160	160-164	0,62	4,45	0,89	0,67
PLGK.2164	164-167	0,65	4,45	0,89	0,67
PLGK.2167	167-170	0,69	4,45	0,89	0,67
PLGK.2176	176-179	0,72	4,45	1,11	0,89
PLGK.2179	179-182	0,76	4,45	1,11	0,89
PLGK.2189	189-192	0,89	4,45	1,11	0,89
PLGK.2196	196-200	0,92	4,45	1,11	0,89
PLGK.2218	218-221	0,99	4,45	1,11	0,89

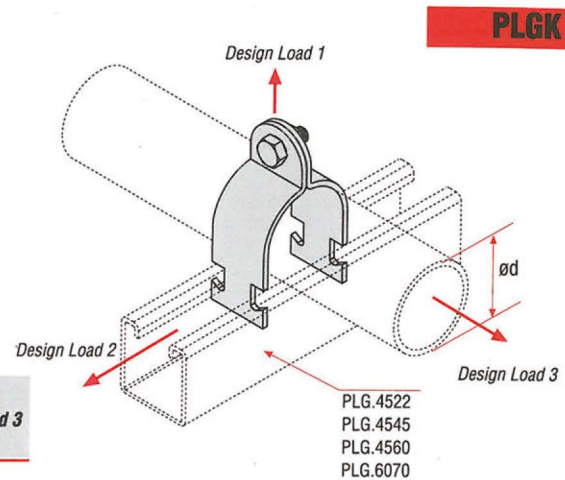

PLGK Standart Dimensions

Code	mm	Pipe Dia. inch	Pipe Dia. DN
PLGK.2015	15-17	3/8	10
PLGK.2021	21-23	1/2	15
PLGK.2026	26-29	3/4	20
PLGK.2032	32-36	1	25
PLGK.2042	42-45	1 1/4	32
PLGK.2046	46-50	1 1/2	40
PLGK.2060	60-63	2	50
PLGK.2074	74-77	2 1/2	65
PLGK.2086	86-90	3	80
PLGK.2112	112-115	4	100
PLGK.2138	138-141	5	125
PLGK.2164	164-167	6	150
PLGK.2218	218-221	8	200

G Channel Nuts

PLGMK

G Channel Nuts

Material : Steel

Standard Finish: Electro Plated Zinc or Hot-Dip Galvanized

Service :

Applicable to all G series with its special design by 'LOCATE, ROTATE, TIGHTEN' method.

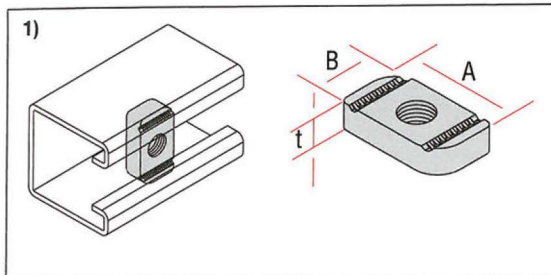

1) Channel Nut Dimensions

Code	Ø mm	A x B x t mm	Ad. / Kutu Pie. / Box	Kg / Kutu Kg / Box
PLGMK.3000	M.8	34 x 19 x 6	900	23,0
PLGMK.3100	M.10	34 x 19 x 8	700	22,5
PLGMK.3200	M.12	34 x 19 x 10	700	23,6

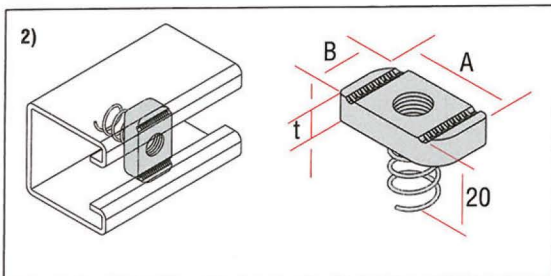

2) Channel with Short Spring Dimensions

Code	Ø mm	A x B x t mm	Ad. / Kutu Pie. / Box	Kg / Kutu Kg / Box
PLGMK.3110	M.10	34 x 19 x 8	400	13,7
PLGMK.3210	M.12	34 x 19 x 10	400	14,3

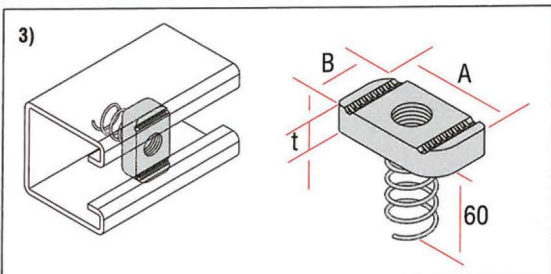

3) Channel with Long Spring Dimensions

Code	Ø mm	A x B x t mm	Ad. / Kutu Pie. / Box	Kg / Kutu Kg / Box
PLGMK.3120	M.10	34 x 19 x 8	200	7,4
PLGMK.3220	M.12	34 x 19 x 10	200	7,6

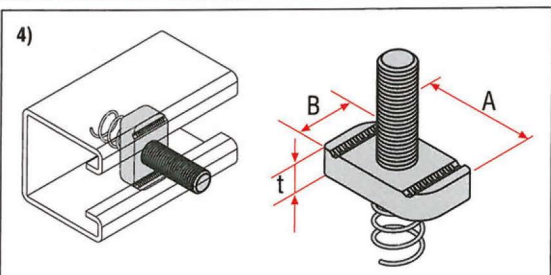

4) Channel Stud with Spring Dimensions

Code	Ø mm	A x B x t mm	Ad. / Kutu Pie. / Box	Kg / Kutu Kg / Box
PLGMK.3121	M.10 x 35	34 x 19 x 6	400	20,3
PLGMK.3122	M.10 x 55	34 x 19 x 8	400	22,5
PLGMK.3221	M.12 x 35	34 x 19 x 6	400	24,8
PLGMK.3222	M.10 x 55	34 x 19 x 8	150	12,3

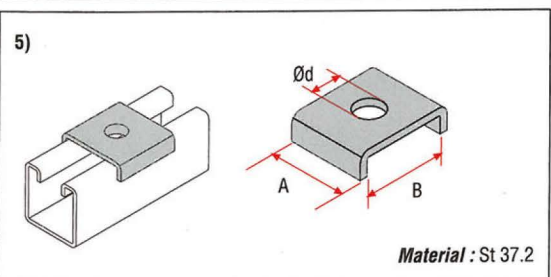

5) Support Washer Dimensions

Code	Ød mm	A x B mm	Ad. / Kutu Pie. / Box	Kg / Kutu Kg / Box
PLGMK.4500	M.13	41 x 45	200	17,4

Material : St 37.2



VESTON



VESTON



VESTON



VESTON



VESTON



VESTON



VESTON



VESTON



VESTON



VESTON



VESTON



VESTON



VESTON



VESTON



VESTON



VESTON



VESTON



VESTON



VESTON



VESTON



VESTON



VESTON



VESTON



VESTON

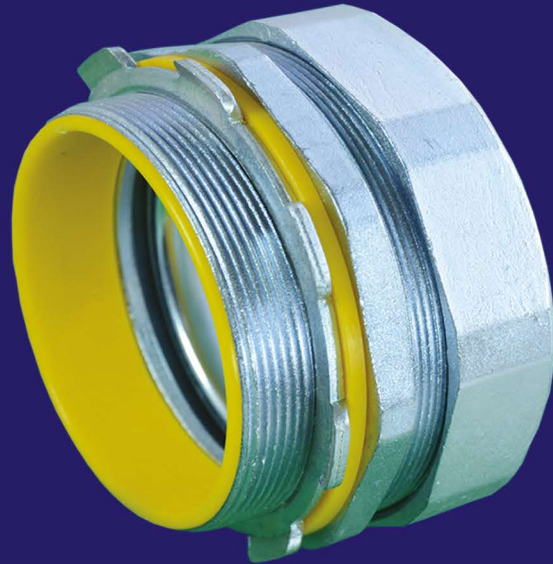

Address: No9, Bazaar Sanaat Mall, South Lalezar St, Tehran, Iran

Tel: +982133976132 Fax: +982133976128

 +989128892460

veston@veston-electrics.ir
www.veston-electrics.ir
